

BELT PULLING WINCHES

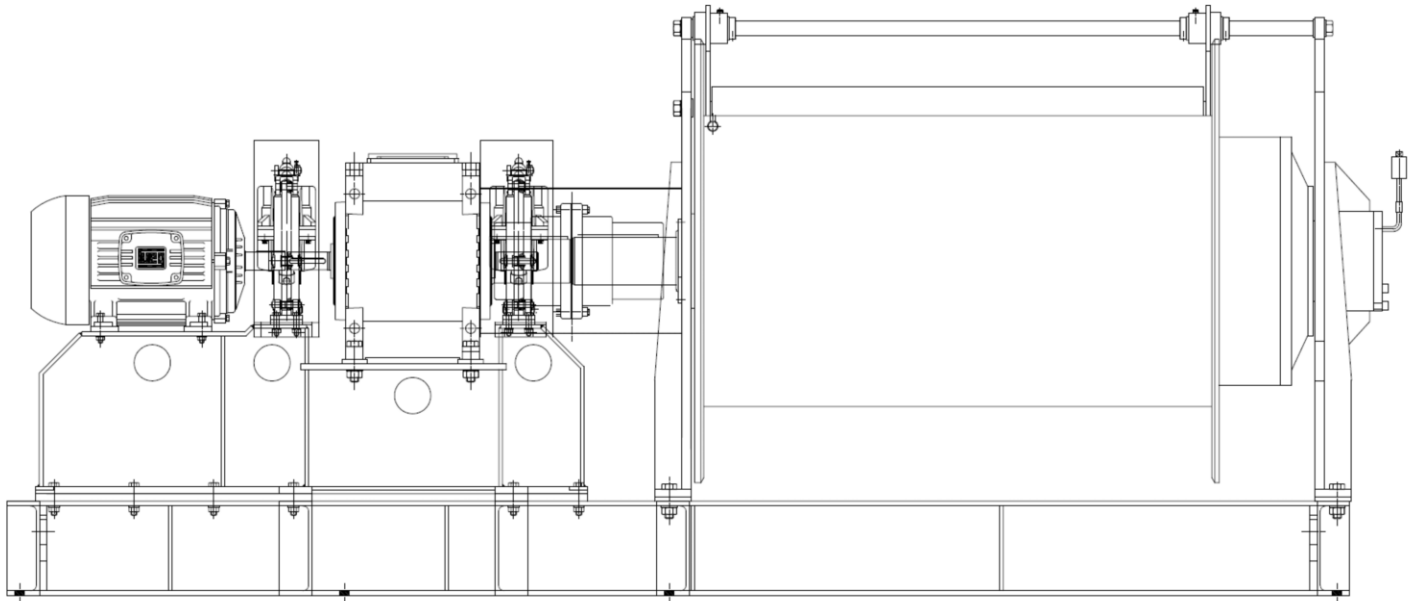

GENERAL INFORMATION

The DYMOT range of belt pulling winches have been specifically designed and developed to meet our client's need to install conveyor belts over extended distances. These winches are based on our take-up winch range with the exception that it can accommodate longer pull and operate at faster speeds.

The belt pulling winch can be operated either DOL or with a VFD. The winch offers an electromagnetic brake for the smaller types and thruster operated drum brakes for the larger types

SPECIFICATIONS

TYPE / MODEL	ITEM NR	MOTOR	TEST LOAD LAYER 1	SWL TOP LAYER	ROPE SPEED LAYER 1	ROPE Ø	DRUM CAPACITY	WORKING LENGTH
15kW	4577	15W - 4P	6.5 Ton	4.5 Ton	9.5 m/min	18 mm	700 m	500 m
18.5kW	5043	18.5kW - 4P	6.5 Ton	4.5 Ton	10.3 m/min	18 mm	1100 m	1000 m
22kW	4668	22kW - 4P	14 Ton	10 Ton	7.4 m/min	26 mm	700 m	500 m

NOTE: These are DYMOT standard products, specials available on request.